

wedi Fundo Rinnenabdeckung

Standard | linear channel cover standard | barrette standard

Exklusiv | linear channel cover exclusive | barrette exclusive

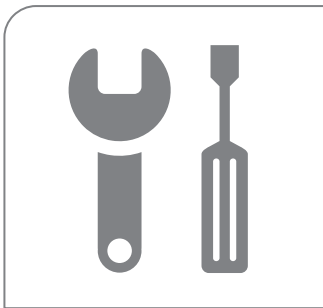

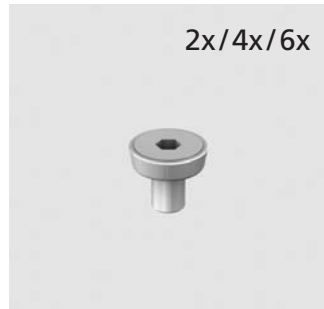
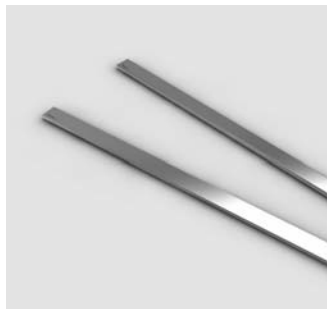
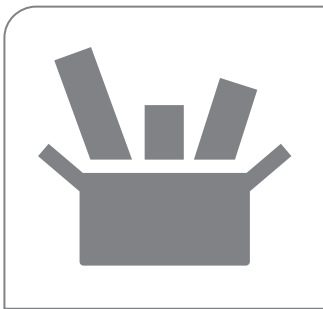

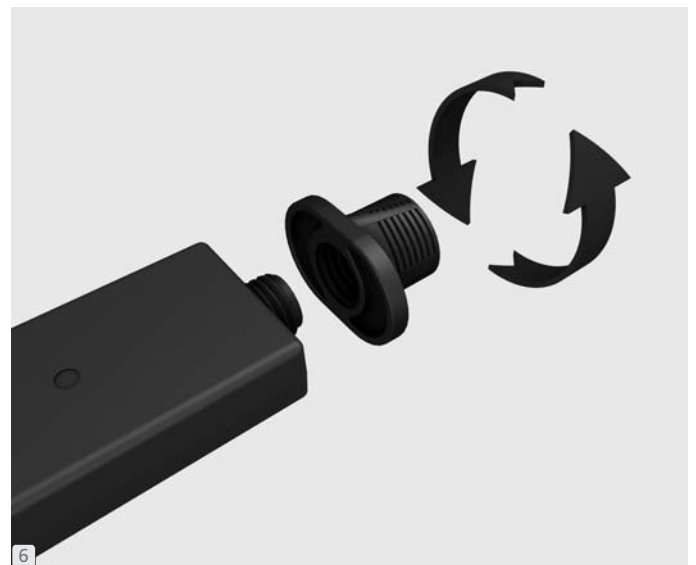
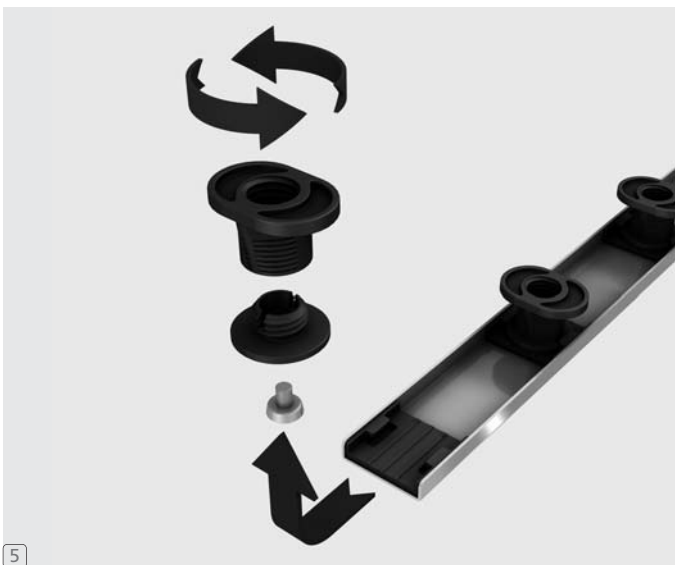
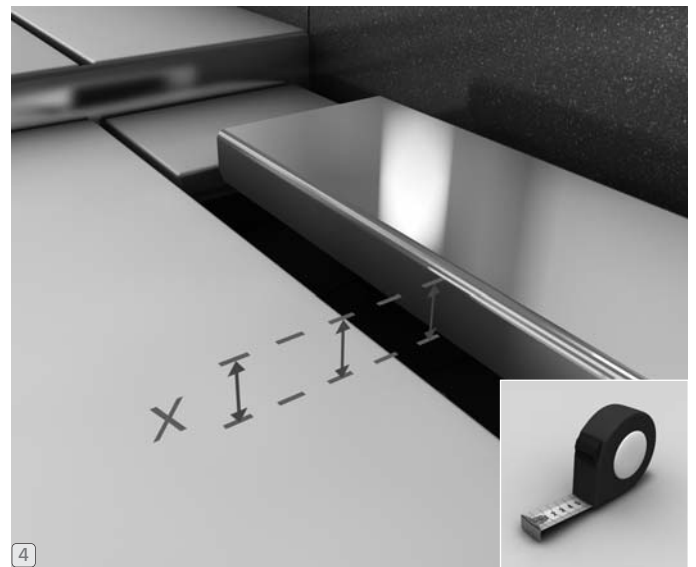
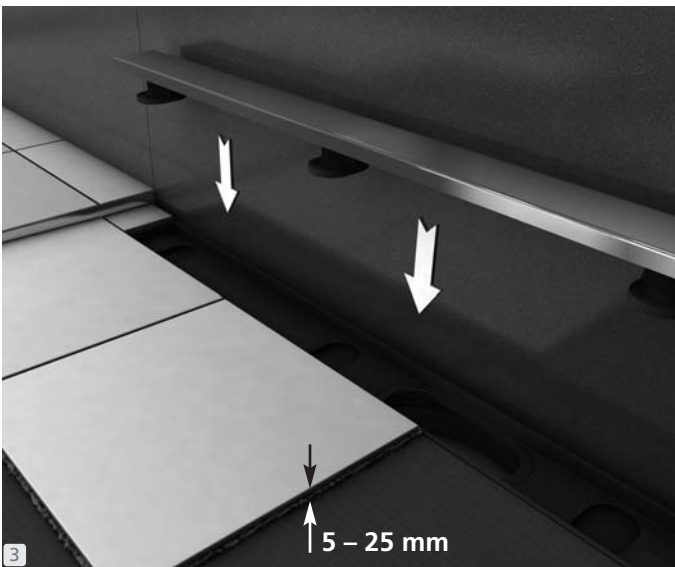
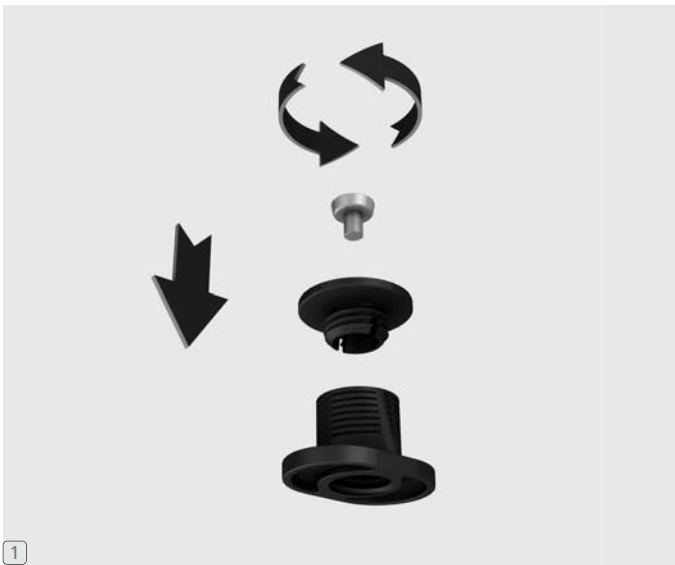

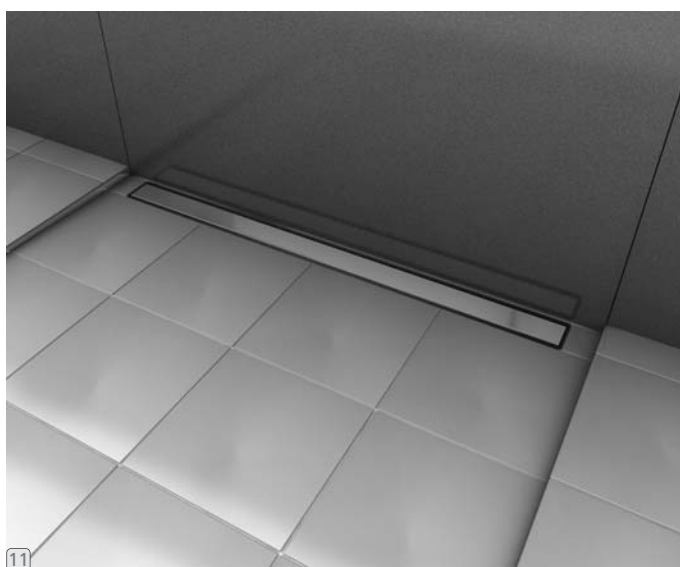
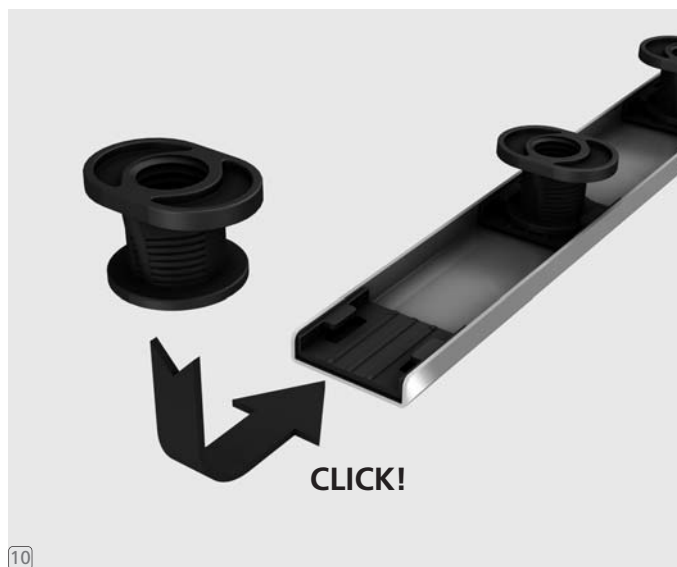
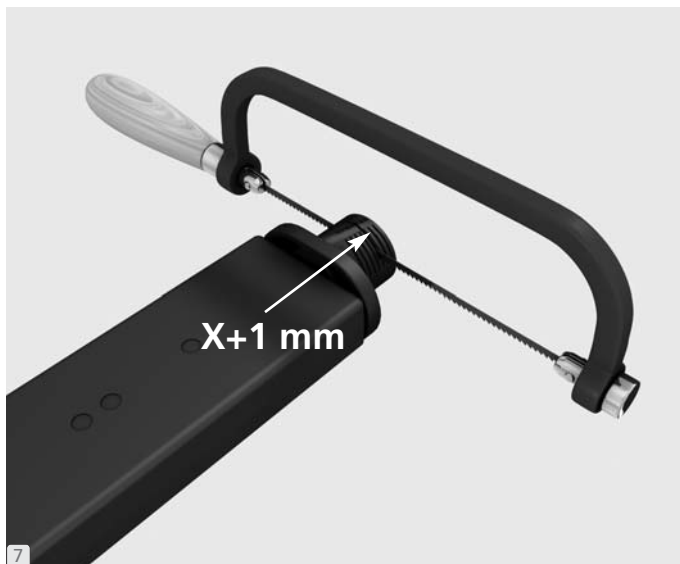

...wedi®

wedi GmbH
Hollefeldstraße 51 · D-48282 Emsdetten
Tel. +49 2572 156-0 · Fax +49 2572 156-133
info@wedi.de · www.wedi.eu